

Cast Pendant



Pendant

Lighting — Product Sheet
menu.as

by Tom Chung & Jordan Murphy



Cast Pendant

Product Type

Pendant

Production Process

Sand casted aluminum with a painted finish

Environment

Indoor

Dimensions (cm / in)

Shape 1	Shape 2
H: 12 cm / 4,7"	H: 10 cm / 3,9"
Ø: 12 cm / 4,7"	Ø: 9 cm / 3,5"
Shape 3	Shape 4 (Mobile)
H: 15 cm / 5,9"	W: 66 cm / 26"
Ø: 7 cm / 2,8"	D: 12 cm / 4,7"
	H: 25/32 cm / 9,8"/12,6"

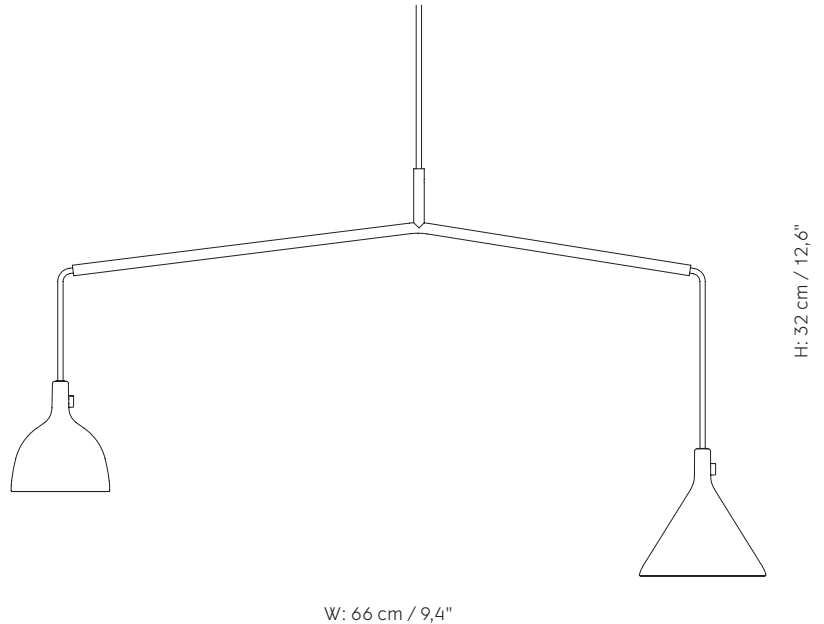

Materials

Cast Aluminum

Colours

Black / Brass

Aluminium / Bronzed Brass

Voltage (V)

220 V

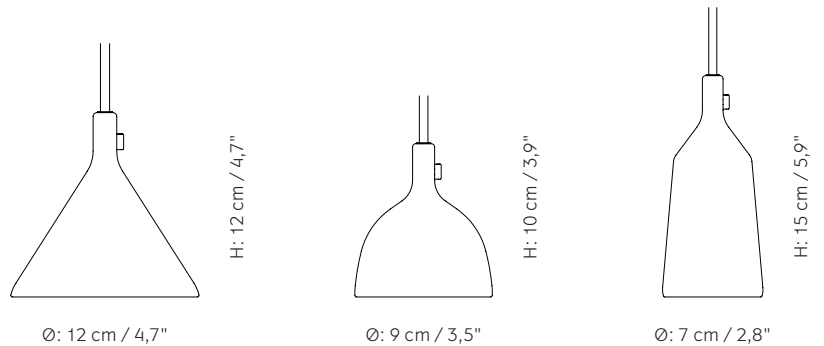

Light source & Energi efficiency class

G9, A++, A+, A, B, C, D

Classification

CE

Certifications

EN 60598-1:2015, EN 60598-2-1:1989,
EN 62493:2015.

Cord lenght / diameter (cm / in)

400 cm / 157.5"

Care Instructions

Use a soft dry cloth to clean. Do not use any cleaners with chemicals or harsh abrasives. Avoid using water.

Cast Pendant takes inspiration from the traditional plumb weight - a weight hanging from a line used by masons and carpenters since Ancient Egypt to establish a true vertical. An honest light, Cast Pendant embodies MENU's philosophy of soft minimalism. Hang one lamp on its own or cluster several into an installation. The lamp is available in three variations, and a splitter allows for variety of configurations. Cast Pendant is designed for both commercial and residential use, and the use of LED technology enables a unexpected small scale, each light only measures 10-13cm tall.

About the Designer

Tom Chung is an industrial designer focused on material objects and space. He established his studio in 2015. Jordan Murphy is a designer who applies technical insight and curiosity to create simple and thoughtful objects. The two are based in Toronto, Canada and share an appreciation for functional and honest design. Cast Pendants is their first collaboration with MENU.

Shape 1



Black / Brass
1210539



Aluminium / Bronzed Brass
1210009

Shape 2



Black / Brass
1220539



Aluminium / Bronzed Brass
1220009

Shape 3



Black / Brass
1230539



Aluminium / Bronzed Brass
1230009

Shape 4



Black / Brass
1240539



Aluminium / Bronzed Brass
1240009